

4

3

2

1

B

B

A

A

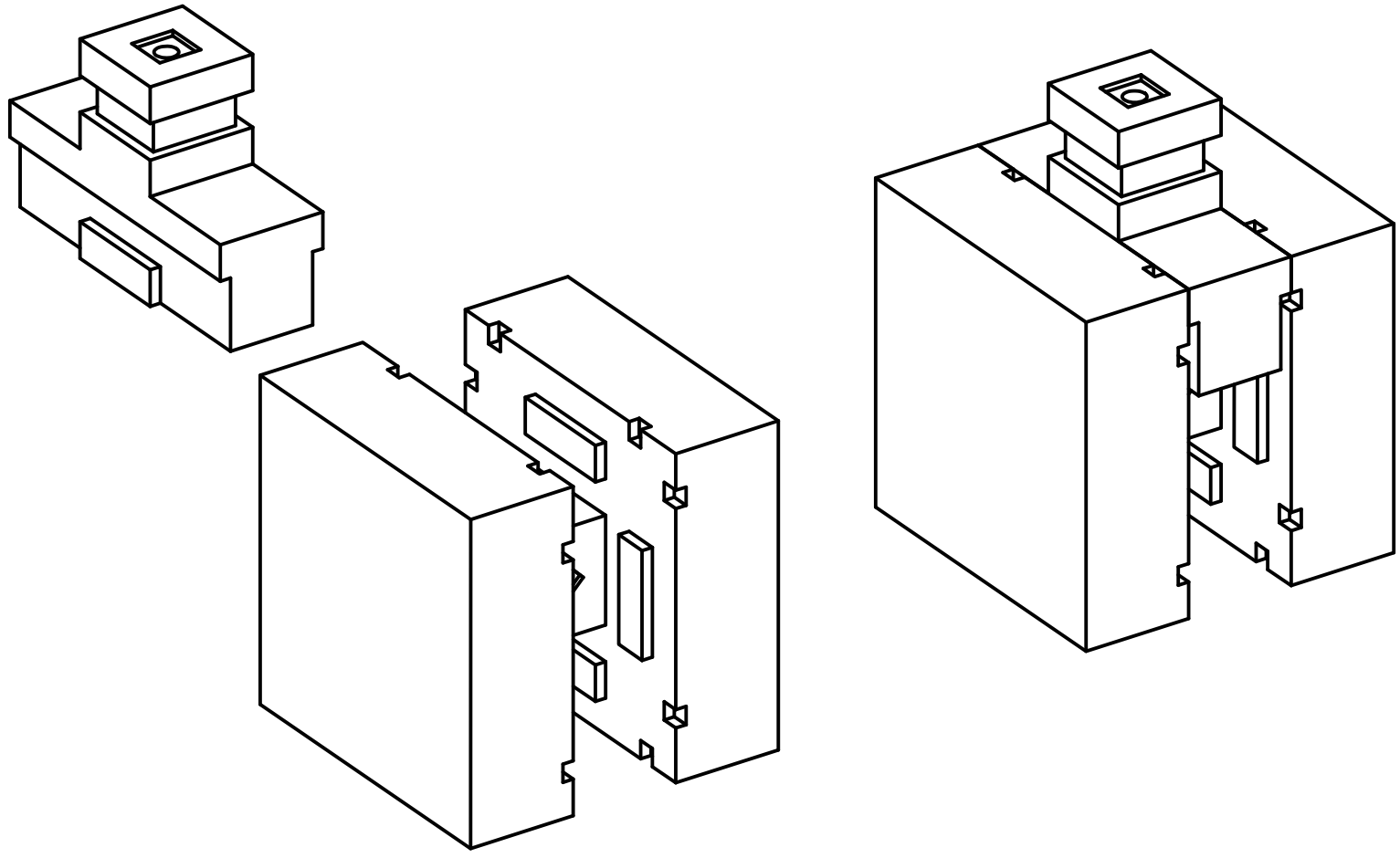

78.iam

4

3

2

1