

4

3

2

1

B

B

A

A

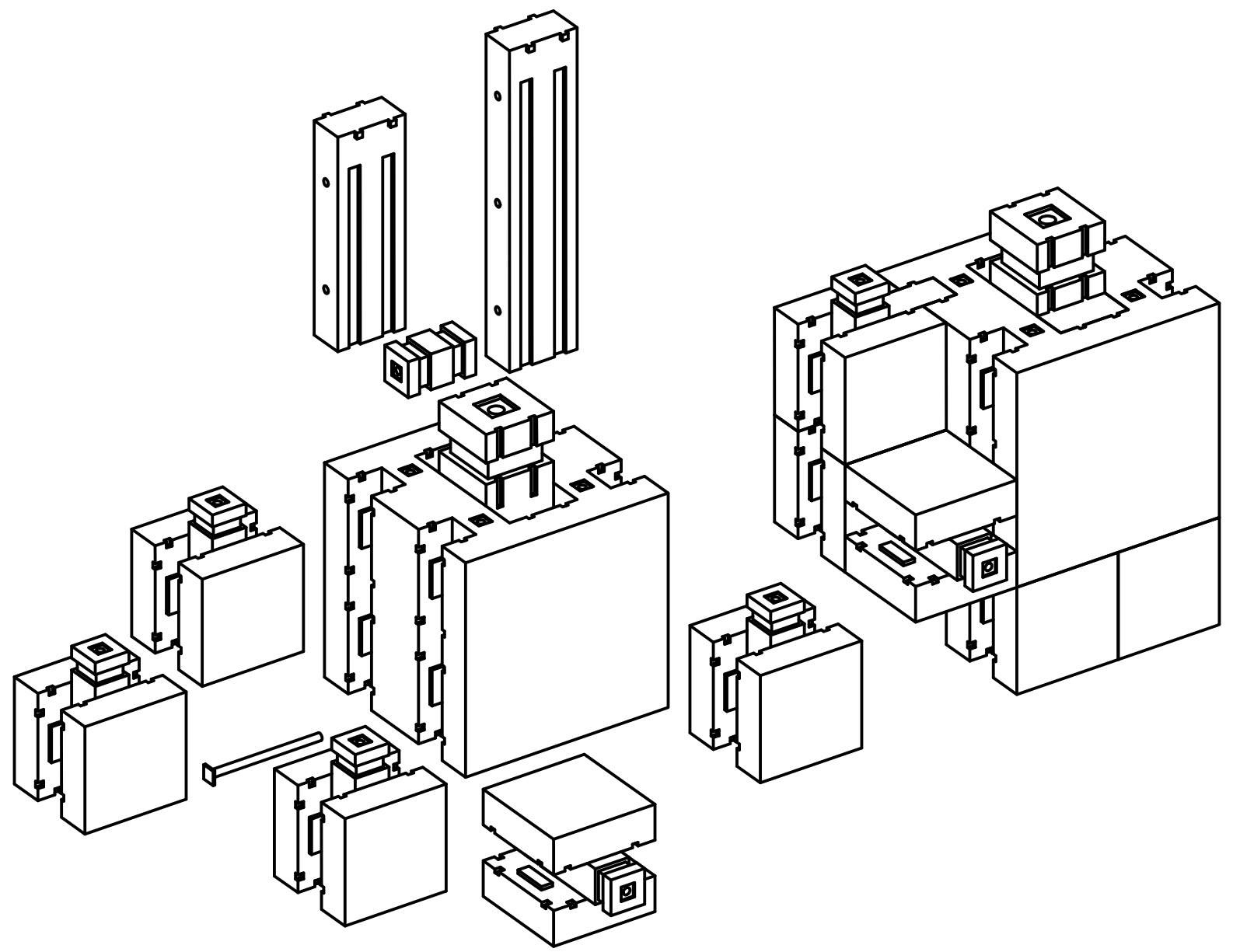

64.iam

4

3

2

1