

4

3

2

1

B

B

A

A

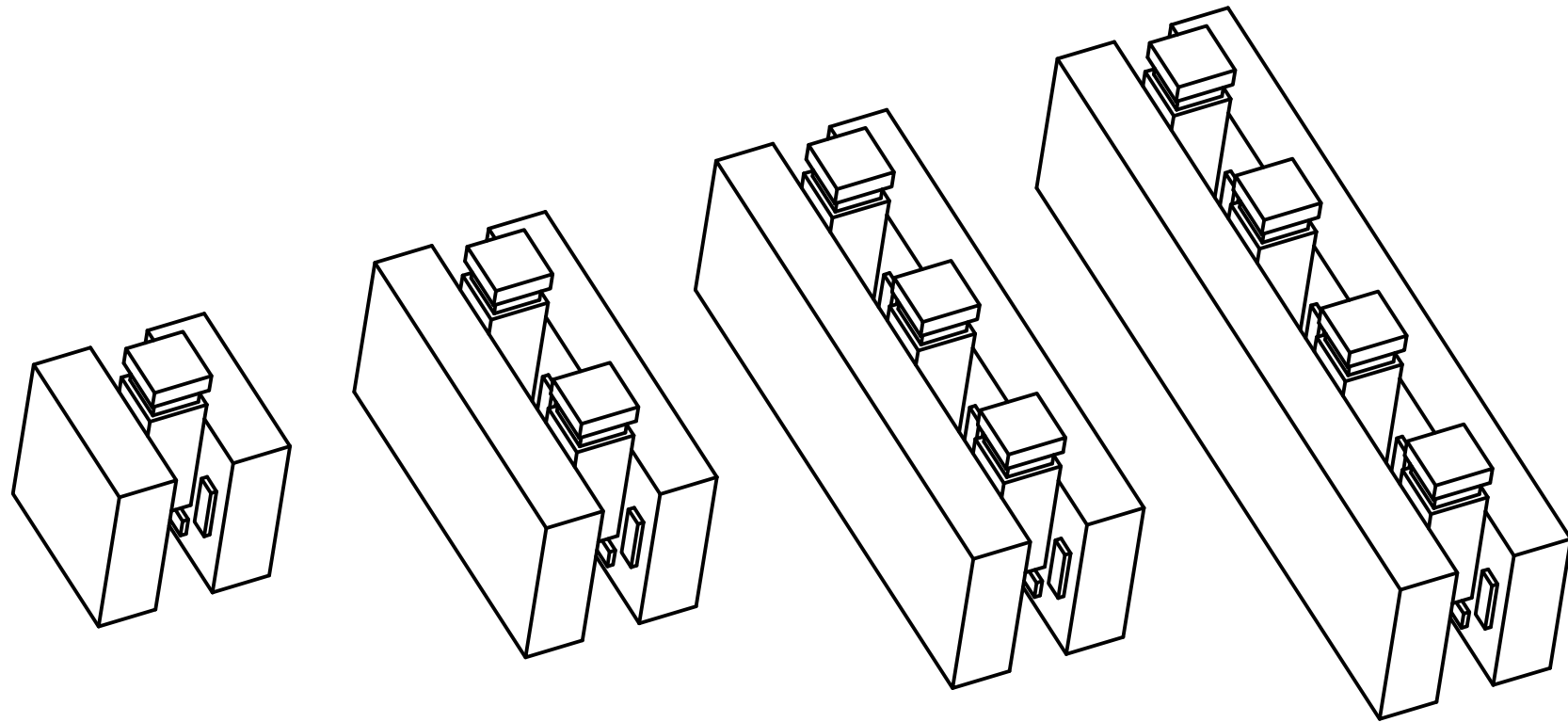

4.iam

4

3

2

1